

Ultrasonic Level Transmitter Manual

■ English



www.ema-electronic.com

Product Introduction

ema Ultrasonic Level Transmitter features with durable and stable operation, simple structure, easy installation

Applications:

Electrical industry, Metallurgical industry, Petroleum and Chemical industry, Food industry, Water treatment, Papermaking, especially suitable for the level measurement of aggressive liquids.

Benefits:

- It is capable of measuring the level of liquid and solid
- High accuracy, low power consumption, and wide measuring range
- Non-contact measurement without any mechanical component. It is ideal applications for solvent, hydrocarbon and petroleum
- Thanks to build-in calibration for speed and frequency, the measurement is more reliable
- Analogue and switching output

Dimensions

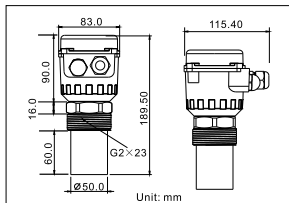

Panel control and display

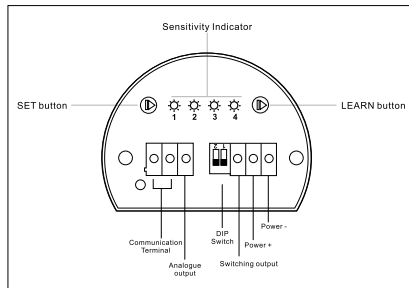

1. The function of DIP Switch
number 1 DIP Switch :NO/NC switching output,
A means NC output to NC;
number 2 DIP Switch :PNP/NPN switching output,
A means NPN output.
2. Buttons Functions
SET: Menu selection;
LEARN: Parameters learning.
3. Indicators
The lamp lights on when there is a switching signals,
otherwise the light is off.
4. Communication Terminal
It is used for upgrade version, not for this product.

Connection

Wiring Diagram

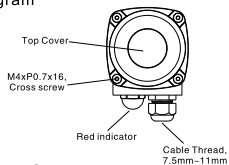

NO/NC Output Connection

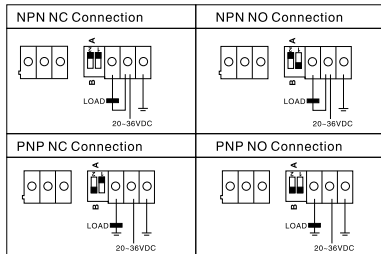

Analogue Output Connection

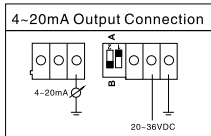

Notice:

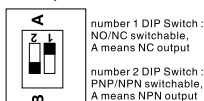

Functions Indication

	Normal working status, lamp 1 flashes
	When the level is higher than Max. point, lamp 2 lights on
	When the level is lower than Min. point, lamp 3 lights on
	Connecting with control box, lamp 4 lights on

This Ultrasonic Level Switch does not support 485 protocols.

- In operating mode:
press "LEARN" button to examine the adjustment of
analogue output.

		Press "LEARN" button, it start to measure the altitude level and lamp 2.3.4 light on. (ASP is on the upper Point and AEP is on the lower Point.)
		Press "LEARN" button, it start to measure the depth level and, and Lamp 2.3.4 light on. (Now AEP is on the upper Point and ASP is on the lower Point.)



















- Unlock Indication:

		Press the two buttons at once for 5 seconds. The unit is unlock when Lamp 1 and 4 flash.
--	--	--





Functions and parameters adjustment

under unlock status



1. Set the SP Point

    	Press "SET" button, lamp 1 flashes
    	Press "LEARN" button, it starts to learn the current parameters and four lamps flash on in turn
   	When the setting is confirmed, lamp 2 and 3 flash
   	When the setting is in error, lamp 2 and 3 flashing alternatively



2. Set the RP Point

   	Press "SET" button, lamp 2 flashes. The following steps are the same as setting the SP
---	--

3. Set the Analogue Start Point (ASP)

  	Press "SET" button, lamp 3 flashes. The following steps are the same as setting the SP
---	--

4. Set the Analogue End Point (AEP)

  	Press "SET" button, lamp 4 flashes. The following steps are the same as setting the SP
---	--

Notice: The frequency of lamp 1 flashes in normal working is different from the flashing frequency of adjusting the parameters.

Function

1. Switching Output

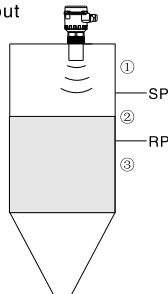

	Normal Open (NO)	Normal Close (NC)
① Position 1—higher than SP	Yes	No
② Position 2—between SP and RP	Delay	Delay
③ Position 3—below RP	No	Yes

Notice:

- (1) The position of SP must be higher than RP. If the value of SP is lower than RP, the system will automatically adjust the value of RP 1 cm lower than that of SP.
- (2) When the value of SP or RP is out of the measuring range, the learning function would be failed.
- (3) The product features with overload protection. When the output current (PNP or NPN) is over 400mA, it will automatically switch off as a protection. After getting rid of overload, the protection can be removed.

2. Analogue Output

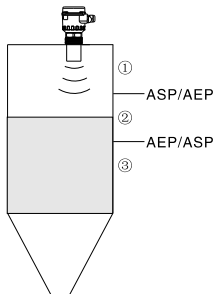

		Adjustment
① Position 1	4mA	ASP on the upper point, AEP on the lower point
	20mA	AEP on the upper point, ASP on the lower point
② Position 2	4~20mA is equally allocated from top to down.	ASP on the upper point, AEP on the lower point
	4~20mA is equally allocated from top to down.	AEP on the upper point, ASP on the lower point
③ Position 3	20mA	ASP on the upper point, AEP on the lower point
	4mA	AEP on the upper point, ASP on the lower point

Notice:

- (1) To ensure the accuracy, the values of ASP and AEP must keep in a proper distance.
- (2) It indicates "Error" While the value of ASP and AEP are out of the detecting range.
- (3) The value of ASP can be lower than AEP or higher than AEP.

Technical Parameters

Measuring range (M)	0.3...8
Inactive area(M)	≤0.3
Accuracy (%)	± 0.1
Response time (s)	1.5
Reversed polarity protection	Yes
Input Voltage (V)	20...36
Current consumption (mA)	< 50
Output	Output 1: NPN or PNP Output 2: 4~20 mA
Watchdog	Yes
Temperature Compensation	Yes
Gain Calibration	Yes
Overload protection	Yes
Max. load of Switching output (mA)	400
Voltage Drop [V]	< 3.5
Operating temperature [°C/°F]	-40...80/-40...176
Min. resolution (mm)	1
Housing material	PA66, ABS, Aluminum Alloy
Protection classification	IP65

Installation Notice

1. Please install the ultrasonic level transmitter at position which is at least 20cm to the vessel wall. Do not install the device in the centerline of tank in order not to receive the false echoes. (see picture ①)
2. Please mount the bottom line of probe being parallel to non-flowing medium. Do not mount the bottom of the device toward filling inlet. It is recommended to install a protective shield if necessary. (see picture ②)
3. Excessively low or high pressure (vacuum) may reduce the echoes. Please use it within the normal pressure range. Foam or too much dust could cause the false echoes which may influence the measuring result. Under such condition, please choose other level products instead. Ultrasonic level switch is not suitable for the use under extreme temperature.
4. The inactive area is the minimum measured distance between the transmitter surface and the medium. When carry out the measurement in the inactive area, it may cause inaccuracy performance. The distance should be greater than inactive area (see picture ③) and the measuring value is the distance between the target media and the surface of probe.

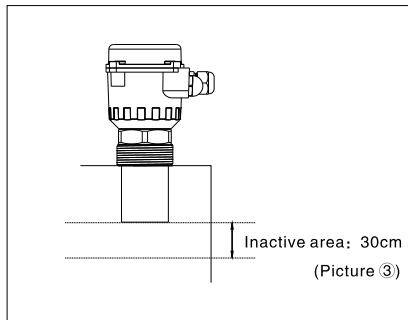
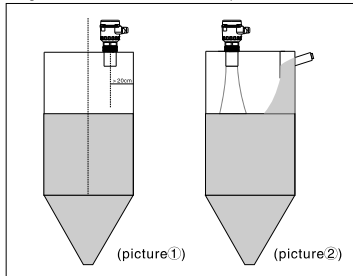

Usage and Storage Notice

1. Please protect the probe against heavy shocking.
2. Please clean the attached materials on the transmitter surface regularly and also keep the surface clean and smooth.

Electrical Connection



The unit must be connected by a technical electrician. The national and international regulations for the installation of electrical equipment must be adhered to.
Voltage supply to EN50178, SELV, PELV
Disconnect the power before connecting the unit

Mini Ultrasonic Level Transmitter Manual

Analogue output

■ English

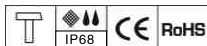

www.ema-electronic.com

Panel control and display

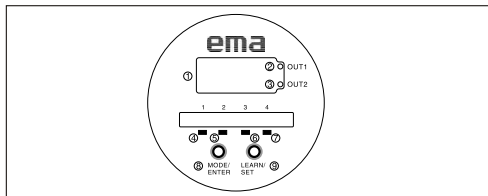

①	7-segment display	Display of current parameters, parameters and parameter value
②	Out1	OUT1 output mode, default is light on (PNP)
③	Out2	OUT2 output mode, default is light on (I)
④	LED1	Display of ultrasonic pulse transmission
⑤	LED2	OUT1 output status: light on with the output
⑥	LED3	OUT2 output status: ASP>AEP light on
⑦	LED4	Detection status: Slow flash in inactive area. It flashes fast when it is out of range
⑧	MODE/ENTER	Parameter selection and parameter value acknowledgement
⑨	LEARN/SET	Setting of learn mode/parameter value

Operation mode

Run mode

- When the power is on, the unit is in the Run mode. It monitors and output the signal according to the set parameters.
- The output value of analogue signal is related to the system measured distance.
- The digital display indicates current parameters setting. The LEDs display the system measured status and system output status.

Lock/Unlock

- Lock: This unit features auto-lock function. If there is no button pressed in 1 minute under Run mode, the unit will be locked automatically.
- Unlock: Keeping pressing "SET" button under normal temperature display status (Run mode), and then press "MODE/ENTER" for 10 seconds until the "ULC" is displayed, meaning that the unit is unlock.

Reset factory default

Keeping pressing "SET" and "MODE/ENTER" at the same time, then connect the power. When flashing "FAC" twice, then it is successful to reset factory default.

Programming Mode

(Setting of the parameter value)

After unlocking the unit, it enters to the Programming mode. When selecting the menu, then enter the parameter display of the menu. Keep pressing "LEARN/SET" until the parameter value is beginning to flash in high level, internally the unit remains in the RUN mode. It continues monitoring the existing parameters until the setting is changed.

It is able to change the parameter value by pressing "LEARN/SET" button, and then pressing "MODE/ENTER" to select the data. When the data is in lowest level, press "MODE/ENTER" to confirm the setting. The unit return to "Run mode" when no button is pressed for 5 seconds.

Function menu

Menu	Function	Range	Method	Remark
SP1	Switching point 1	0.2...3M	Setting from left to right	Distance
rP1	Switching point 2	0.2...3M	Setting from left to right	Distance
ASP	Analogue 1	0.2...3M	Setting from left to right	Distance
AEP	Analogue 2	0.2...3M	Setting from left to right	Distance
OU1	Output 1 mode selection	PnP		Select PNP output
		nPn		Select NPN output
OU2	Output 2 mode selection	I		Select current output
		v		Select voltage output
DiS	Digital display	d	Unit: meter	Select distance display
		S		Select analogue display
		t		Select ambient temperature display

Function

Switching Output

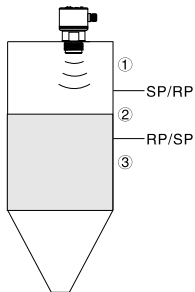

		Setting method
Position 1	Output	SP1 < RP1
	No output	SP1 > RP1
Position 2	Delay	
Position 3	No output	SP1 < RP1
	Output	SP1 > RP1

Notice:

The product features with overload protection and reverse polarity protection. When output current (PNP or NPN) is over 400mA, the unit will switch off the output and enter into protection condition. The protection can be removed after disconnecting overload.

Analogue output

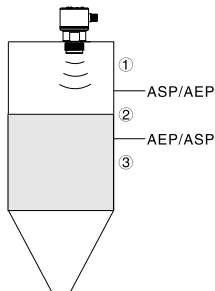

		Setting method
Position 1	4mA	ASP < AEP
	20mA	ASP > AEP
Position 2	4mA~20mA Average distribution	ASP < AEP
	20mA~4mA Average distribution	ASP > AEP
Position 3	20mA	ASP < AEP
	4mA	ASP > AEP

Notice:

Do not set the distance too short between ASP and AEP, otherwise it will affect the accuracy.

Adjustment

①



Press "MODE/ENTER" key several times to select the menu values that need to be adjusted or observed, and press the "SET" key to display the parameters corresponding to the current menu.

②



After choosing the parameter, adjust the value by pressing the "SET" key until high point of parameter flashes. Press "SET" key, the number of value increase flashily. Press "MODE/ENTER" key, and the number of value decrease to low point. For other adjustments, press "SET" key until the parameter value is switched.

③



For numerical values: when flashing number is at the lowest point, quickly press "MODE/ENTER" key (Confirm), the parameter value is displayed again, and the set parameter value become valid. For other adjustments: quickly press the "MODE/ENTER" key (confirm), the parameter value is displayed again, and the set parameter values become valid.

Connection

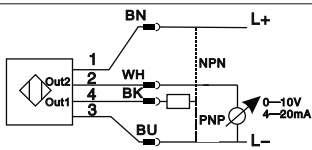

Core color:

- 1 = BN (Brown)
- 2 = WH (White)
- 3 = BU (Blue)
- 4 = BK (Black)

Electrical Connection



The unit must be connected by a technical electrician. The national and international regulations for the installation of electrical equipment must be adhered to.

Voltage supply to EN50178, SELV, PELV
Disconnect the power before connecting the unit

Technical Parameters

Measuring Range [M]	0.2...3
Inactive area [M]	< 0.2
Accuracy / deviation [%]	± 0.1
Reversed polarity protection	yes
overload protection	yes
Temperature compensation	yes
Automatic gain calibration	yes
watchdog	yes
Consumption of current [mA]	50
Input voltage[V]	20...30DC
Min. resolution [mm]	3
Output response time[s]	1.5
Output	output 1: PNP or NPN, output 2: 4-20mA or 0-10V
Analogue output load [ohm]	4...20mA, Max. (U _b -10V)x50
Maximum switching output load [mA]	400
Switching output characteristics	setting as normally open or normally closed
	setting as PNP output or NPN output
	setting as SP point and RP point
Ambient temperature [°C/°F]	-20...70/-4...158
Storage temperature [°C/°F]	-20...70/-4...158
Ambient pressure[ba]	<3
Housing material	Stainless steel 316L; PVDF; Teflon
Protection classification	IP68

Installation Notice

1. Please install the ultrasonic level transmitter at position which is at least 20cm to the vessel wall. Do not install the device in the centerline of tank in order not to receive the false echoes. (see picture 1)
2. Please mount the bottom line of probe being parallel to non-flowing medium. Do not mount the bottom of the device toward filling inlet. It is recommended to install a protective shield if necessary. (see picture 2)
3. Excessively low or high pressure (vacuum) may reduce the echoes. Please use it within the normal pressure range. Foam or too much dust could cause the false echoes which may influence the measuring result. Under such condition, please choose other level products instead. Ultrasonic level switch is not suitable for the use under extreme temperature.
4. The inactive area is the minimum measured distance between the transmitter surface and the medium. When carry out the measurement in the inactive area, it may cause inaccuracy performance. The distance should be greater than inactive area (see picture 3) and the measuring value is the distance between the target media and the surface of probe.

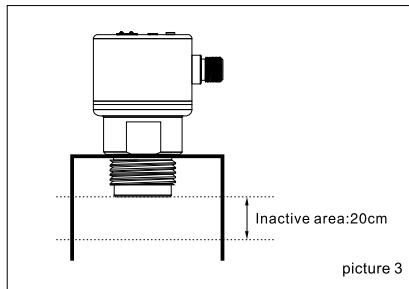
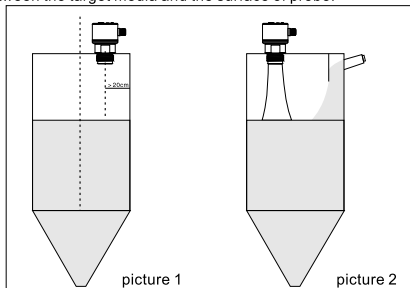

Dimensions

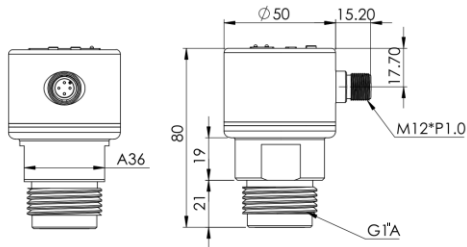

Unit: mm

Usage and Storage notice

1. Please protect the probe against heavy shocking.
2. Please clean the attached materials on the transmitter surface regularly and also keep the surface clean and smooth.
3. The maximum overload pressure of the device should not exceed the defined pressure range 3bar, so as not to damage the device.
4. Install M12 connector and adapter to tighten. Do not lock adapter forcefully and the tighten torque should not exceed 36Nm (350kgf/cm²).



M-VS1002-EN-V1.0

Mini Ultrasonic Level Transmitter Manual

Double Switching Output

- English

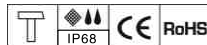

www.ema-electronic.com

Panel control and display

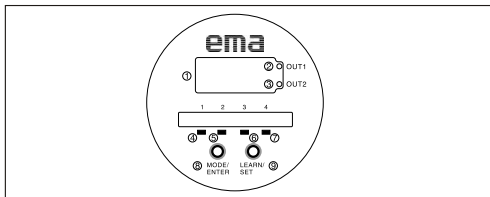

①	7-segment display	Display of current parameters, parameters and parameter value
②	Out1	OUT1 output mode, default is light on (PNP)
③	Out2	OUT2 output mode, default is light on (NPN)
④	LED1	Display of ultrasonic pulse transmission
⑤	LED2	OUT1 output status: light on with the output
⑥	LED3	OUT2 output status: light on with the output
⑦	LED4	Detection status: Slow flash in inactive area. It flashes fast when it is out of range
⑧	MODE/ENTER	Parameter selection and parameter value acknowledgement
⑨	LEARN/SET	Setting of learn mode/parameter value

Operation mode

Run mode

- When the power is on, the unit is in the run mode. It monitors and output the signal according to the set parameters.
- The digital display indicates current parameters setting. The LEDs display the system measured status and system output status.

Lock/Unlock

- **Lock:** This unit features auto-lock function. If there is no button pressed in 1 minute under Run mode, the unit will be locked automatically.
- **Unlock:** Keeping pressing "SET" button under normal temperature display status (Run mode), and then press "MODE/ENTER" for 10 seconds until the "ULC" is displayed, meaning that the unit is unlock.

Reset factory default

Keeping pressing "SET" and "MODE/ENTER" at the same time, then connect the power. When flashing "FAC" twice, then it is successful to reset factory default.

Programming Mode

(Setting of the parameter value)

After unlocking the unit, it enters to the Programming mode. When selecting the menu, then enter the parameter display of the menu. Keep pressing "LEARN/SET" until the parameter value is beginning to flashing in high level, internally the unit remains in the RUN mode. It continues monitoring the existing parameters until the setting is changed.

It is able to change the parameter value by pressing "LEARN/SET" button, and then pressing "MODE/ENTER" to select the data. When the data is in lowest level, press "MODE/ENTER" to confirm the setting. The unit return to "Run mode" when no button is pressed for 5 seconds.

Function menu

Menu	Function	Range	Method	Remark
SP1	Switching point 1	0.2...3M	Bit setting	Distance
rP1	Switching point 2	0.2...3M	Bit setting	Distance
SP2	Switching point 1	0.2...3M	Bit setting	Distance
rP2	Switching point 2	0.2...3M	Bit setting	Distance
OU1	Output 1 mode selection	PnP		Select PNP output
		nPn		Select NPN output
OU2	Output 2 mode selection	PnP		Select PNP output
		nPn		Select NPN output
DiS	Digital display	d	Unit: meter	Select distance display
		t		Select ambient temperature display

Function

Switching output

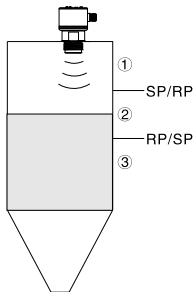



		Setting method
Position 1	Output	SP < RP
	No output	SP > RP
Position 2	Delay	
Position 3	No output	SP < RP
	Output	SP > RP

Notice:

The product features with overload protection and reverse polarity protection. When output current (PNP or NPN) is over 400mA, the unit will switch off the output and enter into protection condition. The protection can be removed after disconnecting overload.

Adjustment

①		<p>Press "MODE/ENTER" key several times to select the menu values that need to be adjusted or observed, and press the "SET" key to display the parameters corresponding to the current menu.</p>
②		<p>After choosing the parameter, adjust the value by pressing the "SET" key until high point of parameter flashes. Press "SET" key, the number of value increase flashily. Press "MODE/ENTER" key, and the number of value decrease to low point. For other adjustments, press "SET" key until the parameter value is switched.</p>
③		<p>For numerical values: when flashing number is at the lowest point, quickly press "MODE/ENTER" key (Confirm), the parameter value is displayed again, and the set parameter value become valid. For other adjustments: quickly press the "MODE/ENTER" key (confirm), the parameter value is displayed again, and the set parameter values become valid.</p>

Connection

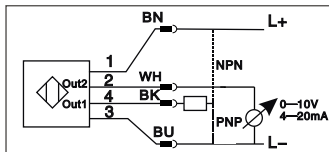

Core color:

- 1 = BN (Brown)
- 2 = WH (White)
- 3 = BU (Blue)
- 4 = BK (Black)

Electrical Connection



The unit must be connected by a technical electrician.

The national and international regulations for the installation of electrical equipment must be adhered to.

Voltage supply to EN50178, SELV, PELV
Disconnect the power before connecting the unit

Technical Parameters

Measuring Range [M]	0.2...3
Inactive area [M]	< 0.2
Accuracy / deviation [%]	± 0.1
Reversed polarity protection	yes
overload protection	yes
Temperature compensation	yes
Automatic gain calibration	yes
watchdog	yes
Consumption of current [mA]	50
Input voltage[V]	20...30DC
Min. resolution [mm]	3
Output response time[s]	1.5
Output	two way switch value output
Maximum switching output load [mA]	400
Switching output characteristics	setting as normally open or normally closed
	setting as PNP output or NPN output
	setting as SP point and RP point
Ambient temperature [C/F]	-20...70/-4...158
Storage temperature [C/F]	-20...70/-4...158
Ambient pressure[ba]	<3
Housing material	Stainless steel 316L;PVDF;Teflon
Protection classification	IP68

Installation Notice

1. Please install the ultrasonic level transmitter at position which is at least 20cm to the vessel wall. Do not install the device in the centerline of tank in order not to receive the false echoes. (see picture 1)
2. Please mount the bottom line of probe being parallel to non-flowing medium. Do not mount the bottom of the device toward filling inlet. It is recommended to install a protective shield if necessary. (see picture 2)
3. Excessively low or high pressure (vacuum) may reduce the echoes. Please use it within the normal pressure range. Foam or too much dust could cause the false echoes which may influence the measuring result. Under such condition, please choose other level products instead. Ultrasonic level switch is not suitable for the use under extreme temperature.
4. The inactive area is the minimum measured distance between the transmitter surface and the medium. When carry out the measurement in the inactive area, it may cause inaccuracy performance. The distance should be greater than inactive area (see picture 3) and the measuring value is the distance between the target media and the surface of probe.

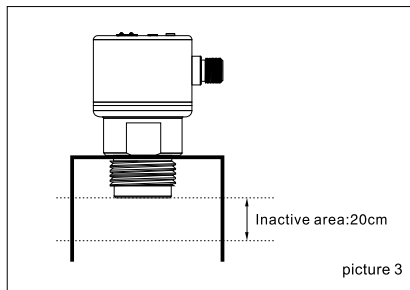
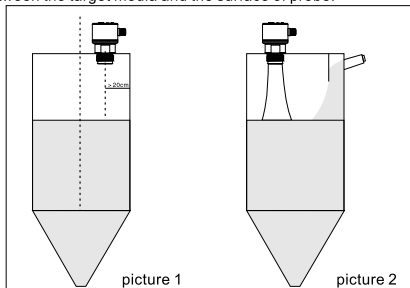

Dimensions

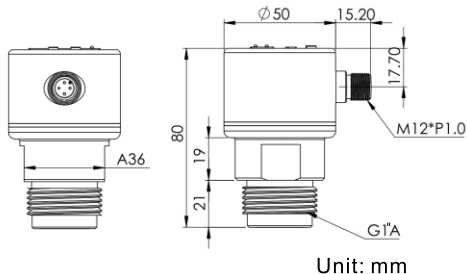

Usage and Storage notice

1. Please protect the probe against heavy shocking.
2. Please clean the attached materials on the transmitter surface regularly and also keep the surface clean and smooth.
3. The maximum overload pressure of the device should not exceed the defined pressure range 3bar, so as not to damage the device.
4. Install M12 connector and adapter to tighten it properly. Do not lock adapter forcefully and the tighten torque should not exceed 36Nm (350kgf/cm²).