

Transparent Objects Detection

ESQ Series

Laser

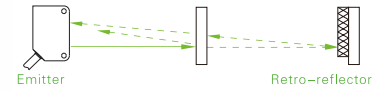

Appearance		
Type	High resolution type	Long distance type
Sensing type	Retro-reflection (Coxial beam)	
Sensing distance	1.5m	4m
Beam size	φ 15mm/1.5m	φ 20mm/3.5m
Output type	NPN/PNP open-collector output, ≤100mA /30V DC	
Switch type	Selectable L.on/D.on	
Indicator	Output indicator: Orange; Laser indicator: Green	
Digital display	7 segments, 3-digit Red LED display	
Response time	0.7 ms	
Time delay	0~999ms Value added unit: 1ms; 1~10ms Value added unit : 1ms	
Sensitivity adjustment	Teach-in button	
Light source	Laser(650nm), Max 1mW	
Laser class	Class2	
Operating voltage	10~30V DC ± 10%	
Current consumption	35mA	
Ambient brightness	Sunlight ≤ 10000Lux, Incandescent lamp ≤ 3000Lux	
Ambient temperature	-10~+50°C, No freezing	
Ambient humidity	35~85%RH, No condensation	
Insulation resistance	≥ 20MΩ (500V DC)	
Impact resistance	50G(500m/s ²), XYZ three directions	
Certificate	IEC, EC	
Degree of protection	IP67	
Material	Housing: Antibacterial ABS; lens: PMMA	
Accessories	Bracket	
Model No.	NPN PNP	ESQ-150N HOT ESQ-150P
		ESQ-400N ESQ-400P

Dimensions

Unit: mm

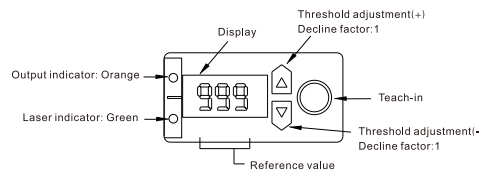
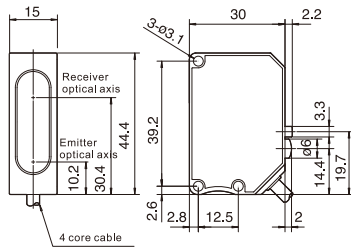

Reflector:

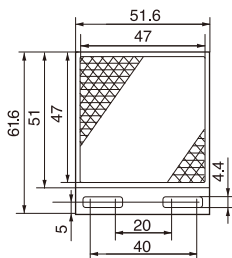

(Standard TD-13)

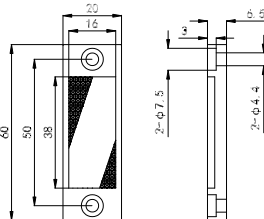

(Optional TD-14)

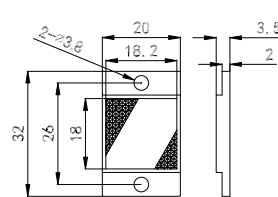

(Optional TD-15)

Circuit diagram

NPN Output

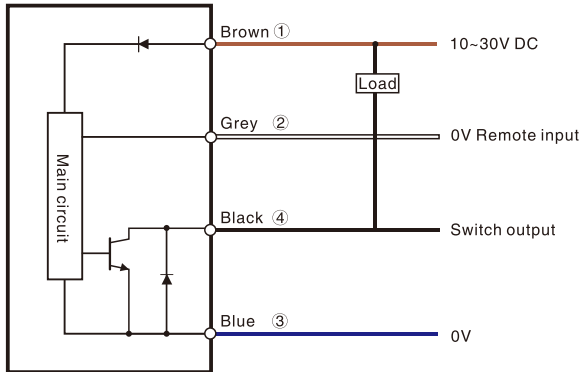

PNP Output

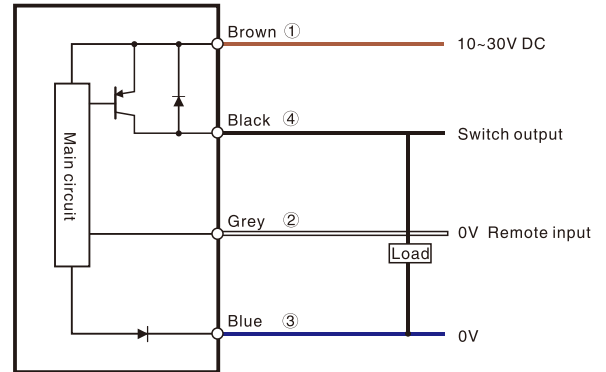

Fiber Optic

Slot Sensors

Photoelectric

Laser

Proximity

Displacement

Magnetic

Contact

Area

Ultrasonic

Vision

Vibration

Temperature

Annexes

Guidance

Laser sensors

Square

BGS

Transparent objects detection